

PRODUCT OVERVIEW

Valves ■ Actuators ■ Automation Technology



The valve people



EBRO ARMATUREN

Our expertise for your applications

We have been developing, producing and selling industrial valves and actuator systems for more than 40 years. Today we are acknowledged as one of the world's leading manufacturers within this field. Employing around 1000 people, we operate with an extensive network of production locations, branches and subsidiaries. This provides us with a solid platform from which to supply the global market with high-quality products, making us a well-established partner in the field of international plant engineering.

Outstanding quality

A quality management system which was first certified to EN ISO 9000 in 1993, conformity to PED (Pressure Equipment Directive) and qualified documentation in accordance with the Machinery Directive guarantee the highest quality. This quality, our experience and the appropriate expertise can be found in a diverse product range that offers solutions for virtually any application.

Customised components

We are able to offer customised solutions for automated valves, given the fact that we produce both the valve and the actuator ourselves. A dedicated business division guarantees precise coordination of valves, actuators and automation technology. The result is an end-to-end portfolio that also fulfils all process engineering requirements in terms of energy efficiency. The coordinated package of high-quality valve and pneumatic actuator can also be precisely matched to the specific application. This matching of components reduces air and energy requirements, as well as streamlining the overall costs of such solutions.

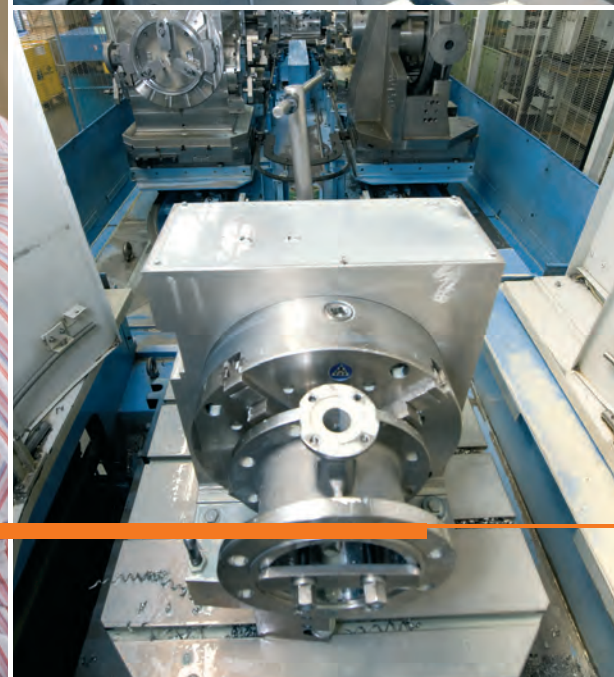

CONTENTS

The right valve for every application

RESILIENT SEATED VALVES

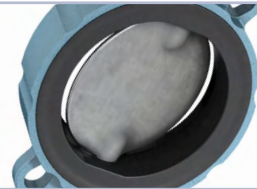

PTFE VALVES



HIGH PERFORMANCE VALVES



ACTUATOR TECHNOLOGY



AUTOMATION TECHNOLOGY



KNIFE GATE VALVES



SPECIAL APPLICATIONS





RESILIENT SEATED VALVES

Thanks to their design and material diversity, centrally mounted, resilient seated shut-off and control valves are almost universally usable.

Whether the medium is water, powder or gas – with a broad range of materials and our expertise based on 40 years of experience, we can offer you the optimal solution for your application.

General information

- Can be used as a shut-off and a control valve
- Insulation height according to Heating Systems Regulations
- Any installation position
- Multiple shaft bearings
- Maintenance-free

Example fields of application

- Chemical and petrochemical industry
- Water and wastewater technology
- Pneumatic materials handling technology
- Shipbuilding
- Power generation industry
- Swimming pool technology
- Building services engineering
- Seawater desalination

Product advantages at a glance

Type Z 011-A

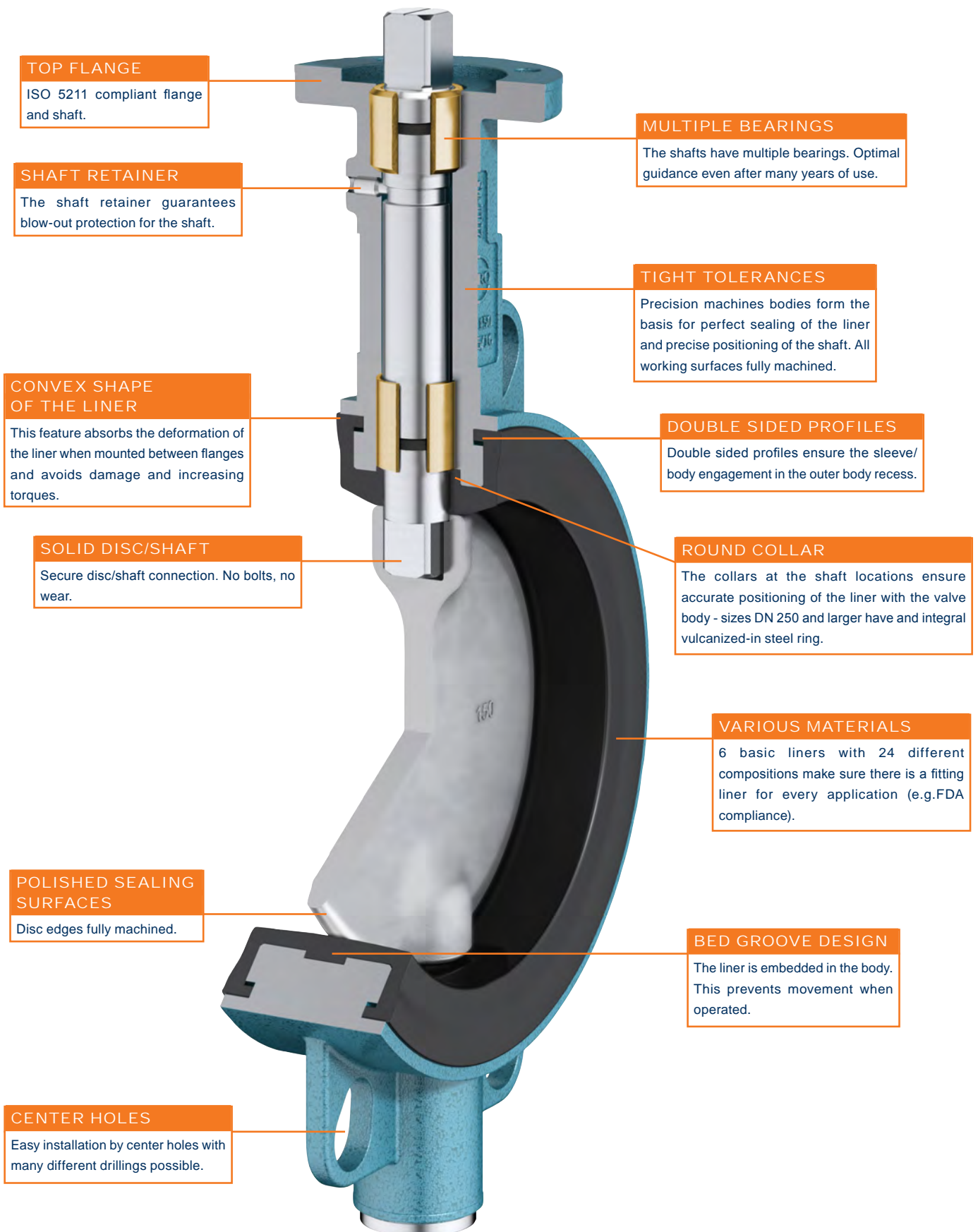

TOP FLANGE

ISO 5211 compliant flange and shaft.

MULTIPLE BEARINGS

The shafts have multiple bearings. Optimal guidance even after many years of use.

SHAFT RETAINER

The shaft retainer guarantees blow-out protection for the shaft.

TIGHT TOLERANCES

Precision machines bodies form the basis for perfect sealing of the liner and precise positioning of the shaft. All working surfaces fully machined.

CONVEX SHAPE OF THE LINER

This feature absorbs the deformation of the liner when mounted between flanges and avoids damage and increasing torques.

DOUBLE SIDED PROFILES

Double sided profiles ensure the sleeve/body engagement in the outer body recess.

SOLID DISC/SHAFT

Secure disc/shaft connection. No bolts, no wear.

ROUND COLLAR

The collars at the shaft locations ensure accurate positioning of the liner with the valve body - sizes DN 250 and larger have an integral vulcanized-in steel ring.

VARIOUS MATERIALS

6 basic liners with 24 different compositions make sure there is a fitting liner for every application (e.g. FDA compliance).

POLISHED SEALING SURFACES

Disc edges fully machined.

BED GROOVE DESIGN

The liner is embedded in the body. This prevents movement when operated.

CENTER HOLES

Easy installation by center holes with many different drillings possible.

WAFER-TYPE VERSION

Technical data

Nominal diameters:

DN 20 – DN 1200

Face-to-face:

EN 558 Series 20

ISO 5752 Series 20

API 609 Table 1

Flange accommodation:

EN 1092 PN 6/10/16/25

ASME Class 150

AS 4087 PN 16/21

Flange surface design:

EN 1092 Form A/B

ASME RF, FF

Top flange:

EN ISO 5211

Marking:

EN 19

Tightness check:

EN 12266 (Leakage Rate A)

ISO 5208, Category 3

Applicable standard:

EN 593

Temperature range:

-40 °C to +200 °C

Operating pressure:

max. 25 bar

Use in vacuum:

Up to 1 mbar absolute



Z 011-A: DN 20 – DN 1200

Universally usable wafer-type butterfly valve in accordance with EN-593. Due to the diversity of base materials available, this valve is suitable for various fields of application.

Reduced internal diameter



Z 411-A: DN 40 – DN 600

This series has been adapted to the reduced internal diameters of PE-/PP pipes. No reworking of the pipe (which causes a reduction of the compressive strength) is necessary.

Lightweight construction



Z 011-AS: DN 50 – DN 300

Thanks to its lightweight design (body: die-cast aluminium) and the optimally matched material combination, this wafer-type butterfly valve is superbly suited for use in plastic pipes, e.g. in the pool industry.

Vulcanised liner



Z 011-B: DN 50 – DN 600

Vulcanised liners are especially suitable in applications where high abrasion resistance or vacuum conditions are criteria for use. Vacuum: 1 mbar absolute

Therm



Z 011-A therm: DN 20 – DN 200

These butterfly valves are ready to accept thermometers, electronic thermo sensors (PT 100) or a system identification plate.

Special coating



Z 011 GMX: DN 50 – DN 300

The lining and coating of this series are designed for abrasive media such as silica sand or porcelain slurry.

Process valve

PAS 1085



Z 611-C / Z 611-A: DN 50 – DN 300

The combination of split body/one-piece disc/shaft connection is primarily used in the beverage and chemical industries, for which a version in accordance with the guidelines of PAS 1085 is supplied.

LUG-TYPE VERSION

Technical data

Nominal diameters:

DN 50 – DN 2000

Face-to-face:

EN 558 Series 13/20

ISO 5752 Series 13/20

API 609 Table 1/2C

Flange accommodation:

EN 1092 PN 6/10/16/25

ASME Class 150/300

AS 4087 PN 16/21

Flange surface design:

EN 1092 Form A/B

ASME RF, FF

Top flange:

EN ISO 5211

Marking:

EN 19

Tightness check:

EN 12266 (Leakage Rate A)

ISO 5208, Category 3

Applicable standard:

EN 593

Temperature range:

-40 °C to +200 °C

Operating pressure:

max. 25 bar

Use in vacuum:

Up to 1 mbar absolute



Z 014 A: DN 25 – DN 600

Lug-type butterfly valve with tapped holes. This design enables downstream pipe dismantling.

Series Z 014-B: Butterfly valve with vulcanized-in liner up to DN 300 available.

Reduced internal diameter



Z 414-A: DN 40 – DN 600

This series has been adapted to the reduced internal diameters of PE/PP pipes. No reworking of the pipe (which causes a reduction of the compressive strength) is necessary.

**Process valve
Split body**

PAS 1085

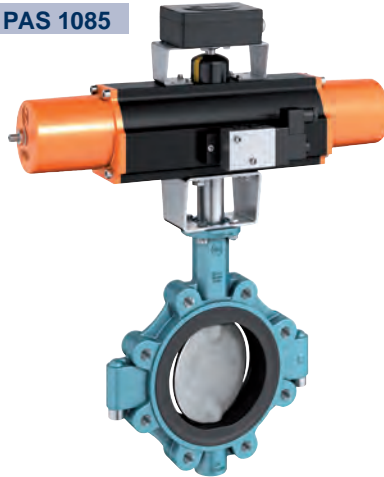

Z 614-A / Z 614-C: DN 50 – DN 300

The combination of split body/one-piece disc/shaft connection is primarily used in the beverage- and chemical industries, for which a version in accordance with the guidelines of **PAS 1085** is supplied.

Full flanged valve



Z 014-WN: DN 50 – DN 600

The full flange design of this valve series provides spaceless sealing with the counterflanges, so objectionable scaling is avoided.

DOUBLE-FLANGED BUTTERFLY VALVES

Centre flanged valve



M 015-A: DN 80 – DN 400

Butterfly valve with centre flange enables the one side lugging of the pipe. Due to the diversity of base materials available, this valve is suitable for various fields of application.

EN 558 Series 13



F 012-A: DN 50 – DN 1400

Double-flanged butterfly valve suitable for use in cooling and industrial water circuits in shipbuilding and in seawater desalination. The vulcanised-in liner is suitable for operating pressures up to max. 25 bar.

EN 558 Series 20



F 012-K1/WN: DN 150 – DN 2000

Double-flanged butterfly valve in short face-to-face length. Suitable for heavy-duty applications such as shipbuilding, waterworks and seawater desalination.



PTFE VALVES

PTFE-lined shut-off and control valves are designed for use in chemically aggressive leaches and acids, for example.

The minimum 3 mm thick lining comprising virgin PTFE ensures optimal permeation protection. In conjunction with the double shaft seal, this series offers maximum operational safety, even with corrosive and toxic media.

General information

- PTFE-lined butterfly valve for chemically toxic and highly corrosive media
- Double shaft seal
- Split body
- Any installation position
- Maintenance-free
- Removable, can be separated for recycling
- Material conform to FDA

Example fields of application

- Chemically toxic and highly corrosive media
- High-purity water and high-purity chemicals
- Pharmaceutical industry
- Adhesives, paper industry, fuel transport
- Paint manufacture and processing
- Food and beverage industry
- Hazardous materials transportation according to EN 14432
- Chlorine production
- Ore processing

Product advantages at a glance

Type T 211-C

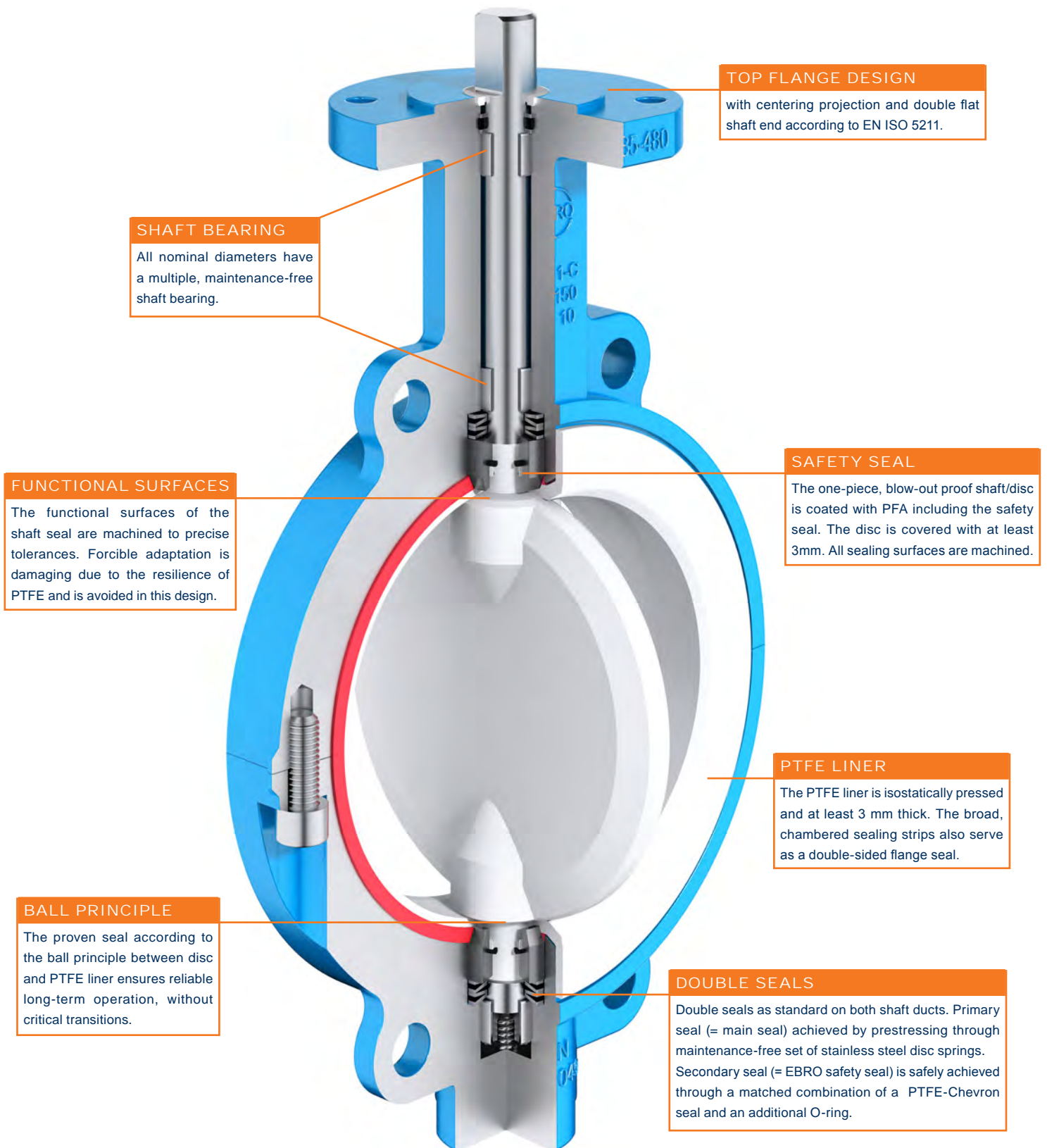

TOP FLANGE DESIGN

with centering projection and double flat shaft end according to EN ISO 5211.

SHAFT BEARING

All nominal diameters have a multiple, maintenance-free shaft bearing.

FUNCTIONAL SURFACES

The functional surfaces of the shaft seal are machined to precise tolerances. Forcible adaptation is damaging due to the resilience of PTFE and is avoided in this design.

SAFETY SEAL

The one-piece, blow-out proof shaft/disc is coated with PFA including the safety seal. The disc is covered with at least 3mm. All sealing surfaces are machined.

PTFE LINER

The PTFE liner is isostatically pressed and at least 3 mm thick. The broad, chambered sealing strips also serve as a double-sided flange seal.

BALL PRINCIPLE

The proven seal according to the ball principle between disc and PTFE liner ensures reliable long-term operation, without critical transitions.

DOUBLE SEALS

Double seals as standard on both shaft ducts. Primary seal (= main seal) achieved by prestressing through maintenance-free set of stainless steel disc springs. Secondary seal (= EBRO safety seal) is safely achieved through a matched combination of a PTFE-Chevron seal and an additional O-ring.

PTFE VALVES

Technical data

Nominal diameters:

DN 50 – DN 900

Face-to-face:

EN 558 Series 20

ISO 5752 Series 20

API 609 Table 2

Flange accommodation:

EN 1092 PN 10/16

ASME Class 150

AS 4087

Flange surface design:

EN 1092 Form A/B

ASME RF, FF

Top flange:

EN ISO 5211

Marking:

EN 19

Tightness check:

EN 12266 (Leakage Rate A)

ISO 5208, Category 3

Applicable standard:

EN 593

Temperature range:

-40 °C to + 200 °C

Operating pressure:

max. 16 bar

Use in vacuum:

Up to 1 mbar absolute



T 211-C: DN 50 – DN 300

PTFE-lined butterfly valve for chemically toxic and highly corrosive media. This series fulfils the requirements of PAS 1085.

Wafer-type butterfly valve



T-211-A: DN 50 – DN 300

Wafer-type butterfly valve for shut-off and control applications in the chemical industry.

Lug-type butterfly valve



T 214-A: DN 50 – DN 300

Lug-type butterfly valve for shut-off and control applications in the chemical industry.

Double-flanged valve



T 212-A: DN 350 – DN 900

Double-flanged butterfly valve for shut-off and control applications in the chemical industry.

Process valve

PAS 1085



T 214-C: DN 50 – DN 300

PTFE-lined butterfly valve for chemically toxic and highly corrosive media. This series fulfils the requirements of PAS 1085.



HIGH PERFORMANCE VALVES

DOUBLE ECCENTRIC DESIGN

High operating pressures and extreme temperatures – wherever other valves reach their physical limits, this series is the ideal solution.

The double eccentric design of the valve disc, high-quality materials and outstanding workmanship ensure safety even in extreme conditions of use. Different sealing systems enable an optimal solution for the respective field of application.

General information

- Shut-off and control of gaseous and liquid media
- Double eccentric design of disc and shaft
- Seat ring systems available:
 - R-PTFE, Inconel and Fire-safe
 - resilient seated (R-PTFE)
max. 230°C
 - metallic seated (Inconel seat)
max. 600°C
- Maintenance-free
- Long lifetime, even with high operating frequencies

Example fields of application

- Chemical and petrochemical industry
- Hot water and steam installations
- District heating supply
- Vacuum systems
- Tanker building
- Gas control equipment
- Food industry
- Materials handling technology

Product advantages at a glance

Type HP 111

STRAIGHT THROUGH SHAFT

ensures maximum bending strength.

MAINTENANCE-FREE BEARING

For all nominal diameters maintenance-free, overlong corrosion and temperature-resistant bearings are used for exact centering of the valve discs.

FORCE-LOCKED CONNECTION

between disc and shaft. Low shear stresses thanks to tangentially arranged tapered pins.

INCONEL SEAT RING

The Inconel seat ring guarantees absolute tightness and compensates for wear. The seat ring can be replaced without disassembling the shaft and valve disc.

Alternative: R-PTFE or Fire-safe

VALVE DISC

The valve disc has a double eccentric bearing design, resulting in low torques and low wear. All sealing surfaces are machined.

CLAMPING RING

protects the seat ring from abrasion and erosion.

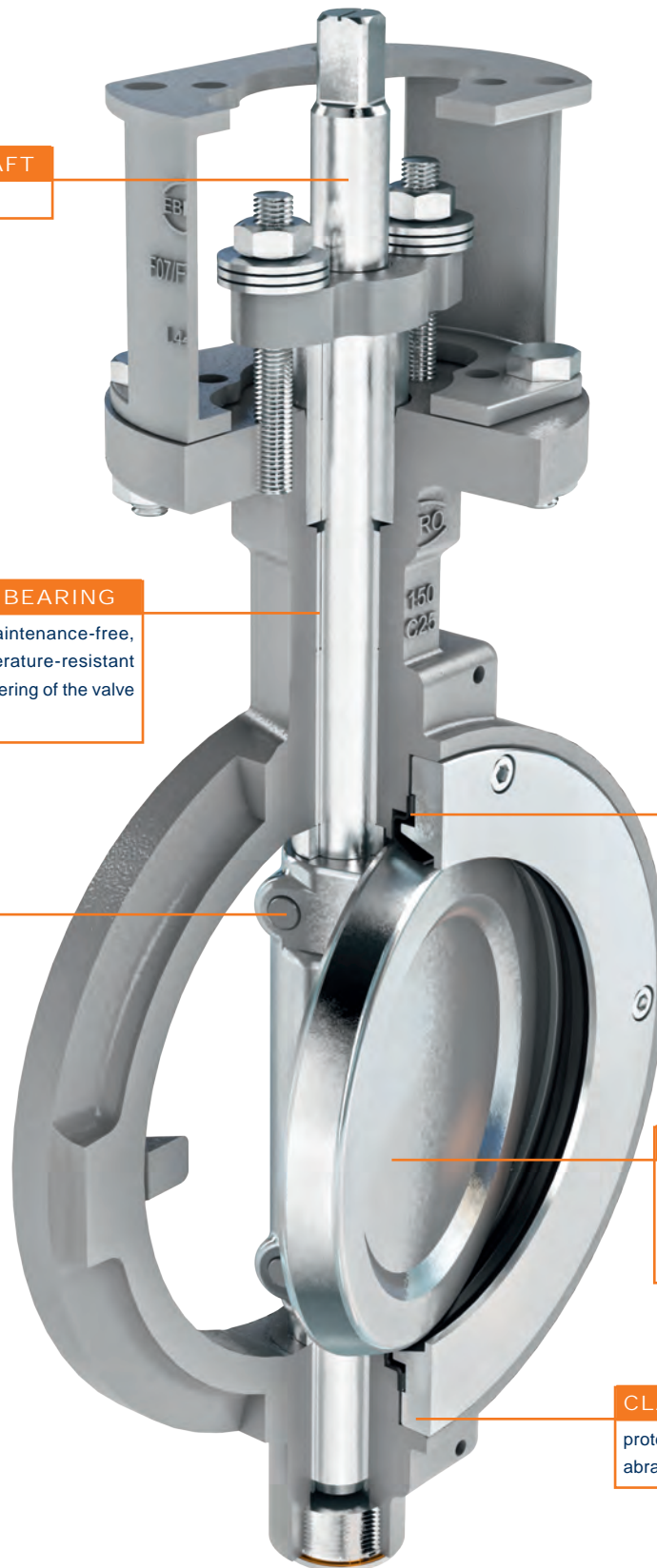

HIGH PERFORMANCE VALVES

Technical data

Nominal diameters:

DN 50 – DN 1200

Larger nominal diameters on request

Face-to-face:

EN 558 Series 13/16/20/25

ISO 5752 Series 20/25

API 609 Table 1

Flange accommodation:

EN 1092 PN 6/10/16/25/40

ASME Class 150/300

AS 4087 PN 16/21

Flange surface design:

EN 1092 Form A/B

ASME RF, FF

Top flange:

EN ISO 5211

Marking:

EN 19

Tightness check:

EN 12266 (Leakage rate A)

R-PTFE seat

EN 12266 (Leakage rate B)

Inconel seat

ISO 5208, Category 3

Applicable standard:

EN 593

Temperature range:

–60 °C to +600 °C

Operating pressure:

max. 40 bar

Use in vacuum:

Up to 1 mbar absolute



HP 114-C: DN 80 – DN 400

Lug-type butterfly valve in double eccentric design. This series fulfils the requirements of **PAS 1085** in respect of material design and marking.

Wafer-type butterfly valve



HP 111: DN 50 – DN 1200

With a selection of corrosion and temperature resistant materials for high pressure and temperature stresses, the HP series offers the perfect solution.

Lug-type butterfly valve



HP 114: DN 50 – DN 1200

Lug-type butterfly valve in double eccentric design. Reliable sealing even under extreme pressure and temperature stresses.

Double-flange valve



HP 112: DN 80 – DN 600

Double-flange type butterfly valve in double eccentric design. Reliable sealing even under extreme pressure and temperature stresses.

Lug-type butterfly valve

EN558 series 16



HP 114 K3: DN 50 - DN 600

This double eccentric lug-type butterfly valve is especially suitable for use with volatile media (such as ammonia, for example). Face-to-face dimension according to EN 558 Series 16.

Economy wafer-type valve



HP 111-E: DN 50 – DN 200

Wafer-type butterfly valve in double eccentric design. This type with split shaft is designed for a max. pressure of 16 bar and offers improved K_V values.

Economy lug-type valve



HP 114-E: DN 50 – DN 200

Lug-type butterfly valve in double eccentric design. This type with split shaft is designed for a max. pressure of 16 bar and offers improved K_V values.



HIGH PERFORMANCE VALVES

TRIPLE ECCENTRIC DESIGN

Reliable quality and long term operational safety - these are the demands for valves used in the Process Industry.

This series of triple eccentric designed shut-off and control valves fulfill these demands even when used with high temperature and - pressure loads.

Design features such as the protected mounting of the sealing within the body - grant high resistance against wear and corrosion. This valve series is applicable with pressure loads up to 63 bar and a max. temperature of 650°C.

General information

- Nominal diameters DN 80 - DN 600
- Operating pressure max. 63 bar
- Flange accommodation: PN40/ PN 63/ Class 300
- Shut-off and control of gaseous and liquid media
- Control performance nearly linear
- Triple eccentric design
- Two versions of the seat ring available:
 - full-metall
 - stainless steel / Graphite lamella seat
- Maintenance-free
- FIRE SAFE BS 6755 PART 2

Significant advantages

- Excellent K_V values due to optimized disk form
- Protected sealing by installation in the housing
- Flange face is not interrupted by the clamping ring screw reductions
- Adjustable shaft sealing

Example fields of application

- Heat power plants
- Refineries
- Paper industry
- Chemical and petrochemical industry
- Hot water and steam systems
- Geothermal energy

Product advantages at a glance

Type HP 300

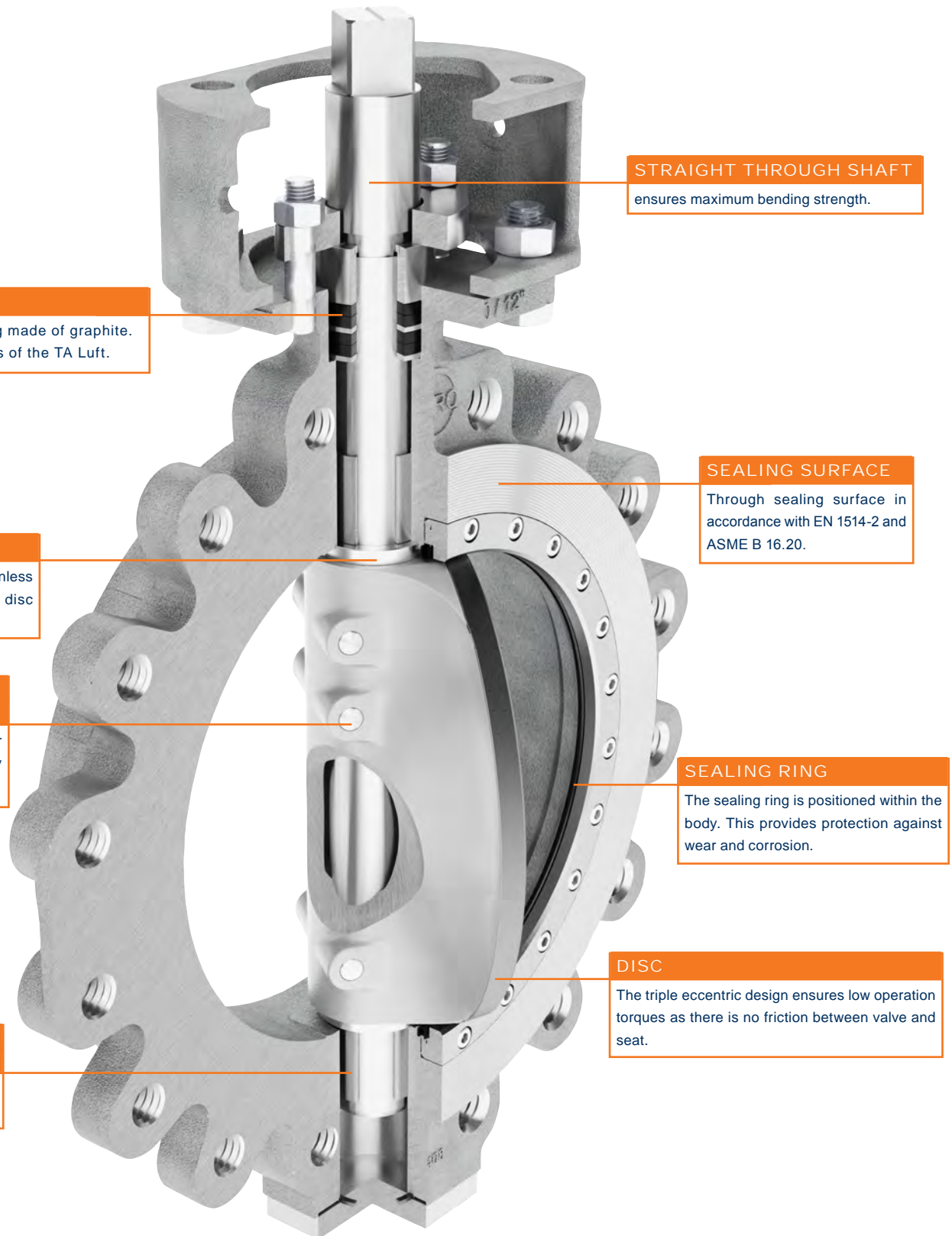

STRAIGHT THROUGH SHAFT
ensures maximum bending strength.

SHAFT SEALING
Adjustable shaft sealing made of graphite.
Fulfills the requirements of the TA Luft.

SEALING SURFACE
Through sealing surface in accordance with EN 1514-2 and ASME B 16.20.

AXIAL BEARINGS
Bearing rings made of stainless steel to ensure optimal disc position.

FORCE-LOCKED CONNECTION
between disc and shaft. Low shear stresses thanks to tangentially arranged tapered pins.

SEALING RING
The sealing ring is positioned within the body. This provides protection against wear and corrosion.

MAINTENANCE-FREE BEARING
made of hardened stainless steel.

DISC
The triple eccentric design ensures low operation torques as there is no friction between valve and seat.



ACTUATOR TECHNOLOGY

Solutions from a single source

Something not many people know: EBRO produces its own actuators – and has been doing so for almost 40 years. For EBRO customers this means that butterfly and gate valves can always be equipped with the most suitable actuator. No compromises, just the best possible match of components – this is what the EBRO actuator series stands for.

Energy-efficient actuators

Pneumatic actuators, single or double acting, have been proven for decades. However, industrial process air is expensive. Energy efficiency is therefore the topic of the day. As a manufacturer of valves and actuators, EBRO can specifically match single product components according to customer requirements and within the scope of operating conditions, thus substantially reducing regular operating costs.

General information

- Maintenance-free
- Available in spring-opening or spring-closing design
- Suitable for all valves with 90° swivel angle
- Blow-out proof shaft bearing
- Nominal torques in accordance with EN ISO 5211
- Easily visible elastic position indicator (alternatively with EBRO target puck)
- All connecting elements made from stainless steel

The advantages

- High opening and closing torques caused by scotch-yoke construction principle
- Very good sliding characteristics thanks to multiple piston guide
- Operational safety and long service life thanks to precise machining of cylinder tube and piston
- Encapsulated spring assemblies enable safe replacement in-situ (only EB-SYS 5.1 – EB-SYS 26.1)

Product advantages at a glance

SPRING UNITS

Single-acting actuators are equipped with two spring cups, so that the actuator can clearly be recognised as single-acting. Six different spring units are available, depending on the actuator size. The springs are prestressed, allowing the spring units to be replaced safely and easily.

PISTON GUIDE

Sliding pads and piston rings made of UHMWPE ensure low-friction piston guidance and prevent metallic contact between piston and cylinder.

CYLINDER

The piston bearing surface of the cylinder tube is precisely machined and anodised. The result: good wear resistance and consistently high efficiency in continuous operation.

SHAFT BEARING

The multiple shaft bearing reduces friction losses to a minimum and guarantees high efficiency.

SCOTCH YOKE CONCEPT

The structurally-dependent lever action is optimally matched to the torque curve.

NAMUR CONNECTION BLOCK

The NAMUR connection block can be rotated by 180° in order to change the function of the solenoid valve from "Normally closed" to "Normally open".

CORROSION-RESISTANT SCREW CONNECTIONS

All screw connections are stainless steel, thus guaranteeing corrosion protection and safe connection even with aggressive recirculating air.

PINNED DOUBLE YOKE

The pinned fitting of the double yoke guarantees backlash-free force transmission and protects the shaft from blow-out.

ADJUSTABLE LIMIT STOPS

The piston limit stop can be adjusted very precisely within a range of $\pm 3^\circ$.

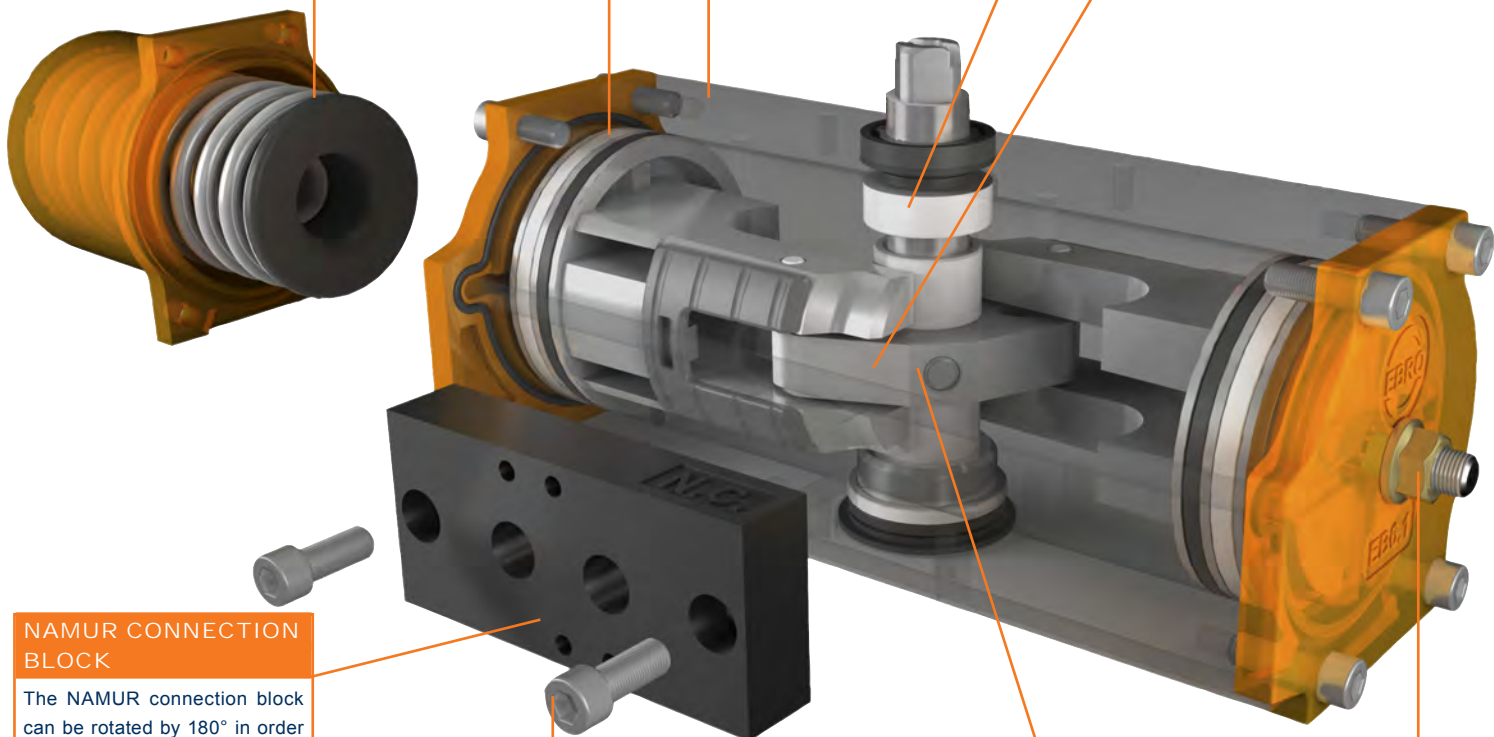

PNEUMATIC ACTUATORS

Technical data

Torque range:

EB-SYD: 27–9768 Nm

EB-SYS: 35–3590 Nm

End positions:

Precisely adjustable to

-8°/+3° as standard

Limit switch and control valve mounting:

VDI / VDE 3845

Control pressure:

Min. 2.5 bar, max. 8 bar

Control air:

Filtered, dry compressed air

Switching cycles ≥ 4 / min.:

please lubricate

Temperature range:

-20 °C to +80 °C (standard)

-40 °C to +80 °C (low temperature)

-15 °C to +120 °C (high temperature)

Valve interface:

EN ISO 5122

Cylinder:

Anodised aluminium

Other coatings on request



EB-SYD:

The EB-SYD series comprises 13 sizes, which are manufactured according to the scotch yoke principle.

Torque range: 27 Nm – 9768 Nm, at 6 bar control pressure.



EB-SYS:

The EB-SYS series comprises single-acting pneumatic actuators with spring-opening and spring-closing.

Torque range: 35 Nm – 3590 Nm, at 6 bar control pressure.

Switch box



This robust aluminium switch box is suitable for direct mounting in accordance with VDI/VDE 3845. Different board configurations enable the installation of various types of microswitches and proximity switches.

AS interface



With the AS-i double sensor both bus communication and power supply (24 V) are jointly transmitted via the yellow AS-i cable.

Positioner

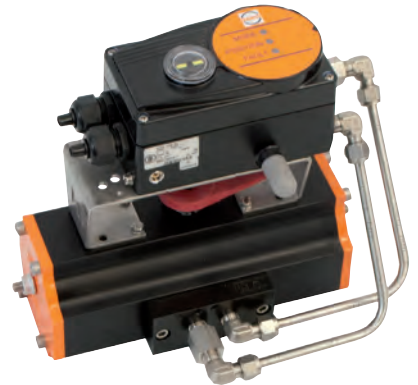

Electronic positioner in analog and digital design for control and feedback of pneumatic actuators. A wide range of versions is available.

Direct mounting



Direct open or protected mounting of limit switches and proximity switches.
Illustration: Limit switch with roller tappet and EBRO target puck with protective cap.

Throttle unit



The EBRO throttle unit - in conjunction with a solenoid valve - enables continuously variable adjustment of the opening and closing times.

Inflas control unit



A complex control unit that fulfils a multitude of functions: defined opening and closing after blow-out and venting of the butterfly valve seal.

PNEUMATIC LINEAR ACTUATORS

Technical data

Type:

Double-acting pneumatic linear cylinder

Piston diameter:

Ø 100
Ø 125
Ø 160
Ø 200
Ø 250
Ø 320

Stroke range:

90 mm to 1030 mm

Max. permissible control pressure:

10 bar

Temperature range:

-20 °C to +80 °C (standard)
High and low temperature
version on request

Capacity range:

4524–46322 N (6 bar)

Control valve mounting:

Namur, VDI / VDE 3845

Control medium:

Filtered, dry compressed air
acc. to ISO 8573-1:2010
min. Class 3
Other control media on request

Mounting flange:

EN ISO 5211

Cylinder:

Housing: anodised aluminium
Cover: powder-coated
Other coatings on request

Options:

Single-acting function
End position damping
Adjustable stroke
Emergency manual override
Special surface finish
Quick-closing function

EC:

The EC linear cylinder series
comprises 6 sizes.

Capacity range: 4524 N – 46322 N
with a control pressure of 6 bar.



Namur interface



The NAMUR interface for direct mounting of control valves and the air ducts integrated into the housing reduce the mounting and tubing required to a minimum.

Position feedback



Integrated keyway in the housing for mounting limit switches in accordance with ISO 15552 for non-contact position detection when using magnetic pistons (optional).



E 50 – E210:

Compact part-turn actuators for energy-efficient valve control. The actuators guarantee high operational reliability thanks to the classic gear unit design with direct torque transmission from the self-locking worm gear to the valve shaft.

The clutch-free emergency manual override enables user-friendly handling during commissioning, system maintenance or in fault situations.

Technical data

Actuator sizes:

E 50 - E 210

Torque range:

40Nm – 4000Nm

Voltages:

24V DC, 24V AC, 230V AC, 400V AC
Other voltages on request

Product characteristics according to EN 15715-2:

- Protection class IP67 (IP68 on request)
- Operation temperature -20°C to 70°C
- Corrosion protection class C4
- Thermally protected motors
- CSA-tested design

Structured basic configuration for safe commissioning

Numerous options:

- Selectable actuating times
- Additional limit switches
- Intermediate position switch
- Potentiometer
- Current feedback 4-20mA
- Initiators
- Self-regulating PTC heating
- Electronic actuating time extension
- Quick-connect Heavycon plug
- AS-i bus control

Control actuator modular system

- Control via 0-10V, 0-20mA or 4-20mA
- Integrated electronic motor control stage
- Control station in-situ
- Redundant position feedback
- Digital control input for direct PLC connection
- Integrated signal and motor monitoring

Fail-safe actuator

Powerful, battery-assisted DC actuators with configurable fail-safe position.

Control actuator



EBRO control actuators, suitable for communication with the usual measuring and control signals, also feature numerous control and monitoring functions.

Battery pack



DC actuators with an integrated battery pack enable safe positioning of the valve in the event of power failure or cable breakage.



AUTOMATION

ACTUATOR SENSOR INTERFACE

The Actuator Sensor Interface is a cost effective alternative to standard wiring. The parallel installation of both bus- and pneumatic supply grants reduced efforts, while the AS-i cable transmits the bus communication as well as the power supply 24V.

These actuators are available for this Interface:

- Pneumatic and electric actuators with binary coded data transfer via AS Interface. The two-core cable transmits the information of the end position as well as the input signal for the actuators.
- Pneumatic Actuators with directly mounted AS-i Positioner. The analogue data transfer of set-value and actual position is managed by the AS Interface.
- Electric open/close actuators with integrated AS-i technology.

General Information

- A cost effective alternative to standard wiring
- A quick and cost effective interface for binary sensors and actuators
- Less operating expenses for terminal strips, E/A Cards and wiring
- Open to be connected to higher fieldbus systems like Profibus, Ethernet
- Standardized acc. to EN 50295, IEC62026
- Simple and quick implementing by diagnostic routine
- The cable reconstructs protection class IP67 even after removal of the connecting module

The advantages

- Both voltage supply (24V) and bus communication transmitted via AS-i wire
- Less installation expenses by parallel installation of bus-and air supply
- Various options for diagnostic routines
- A complete unit to operate valves
- Further modules can easily be installed at any point of the profile cable

AS-i Module for Pneumatic Actuators



The AS-i bus connection is available for all pneumatic actuators series EB. A low power solenoid valve (24V) is controlled through the AS-i cable. The final positions are indicated to a double sensor by a puk.

AS-i Module for Electric Actuators



A bus coupling is also available for EBRO Electric Actuators. Control signals and position indication are transferred via AS-i bus. Only available for 230V AC Actuators.

AS-i Module for Manual Operation



The AS-i bus connection for manual operated valves is achieved by a double sensor equipped with a flat cable connector and two inductive sensors. A puk indicates the valve position.

AS-i Module for Positioners



Electro pneumatic Positioner with integrated AS-Interface. The analogue data transfer of nominal and actual value is managed by the AS-Interface.

AS-i Module for Switch Box Unit SBU



The switch box unit (SBU) is equipped for AS-i bus as follows:
Two micro switches or inductive sensors transmit the valve position. These informations are transmitted through the cable via interface, which also controls a low power (24V) solenoid valve.

AT AS-i Mastersystems



AT Mastersystems provide the Gateway to higher bus systems like Profibus or Ethernet. The „Black Box“ contains all necessary components for the operation of one or two AS-i Networks. The master controls the data transfer to the Sensor/ Actuator level while the controller processes the bus data in the integrated processor (Preprocessing of signals).



KNIFE GATE VALVES

Heavily contaminated and fibrous substances, such as those associated with wastewater systems, biogas plants or paper production, are the fields of application for knife gate valves. In situations where shut-off valves reach their mechanical and physical limits, high-quality gate valves are used. These robust valves are manufactured by our sister company Stafsjö in Sweden.

General information

- TwinPack™ packing gland guarantees high operational reliability
- Low-maintenance
- Easy replacement of seal
- Bi-directional
- Operational reliability

Example fields of application

- Process technology
- Pulp moulding, recycled pulp
- Granulates, bulk goods, powder
- Biogas plants
- Sugar industry
- Power and steel industry
- Chemical industry
- Food industry and breweries

Product advantages at a glance

Type MV

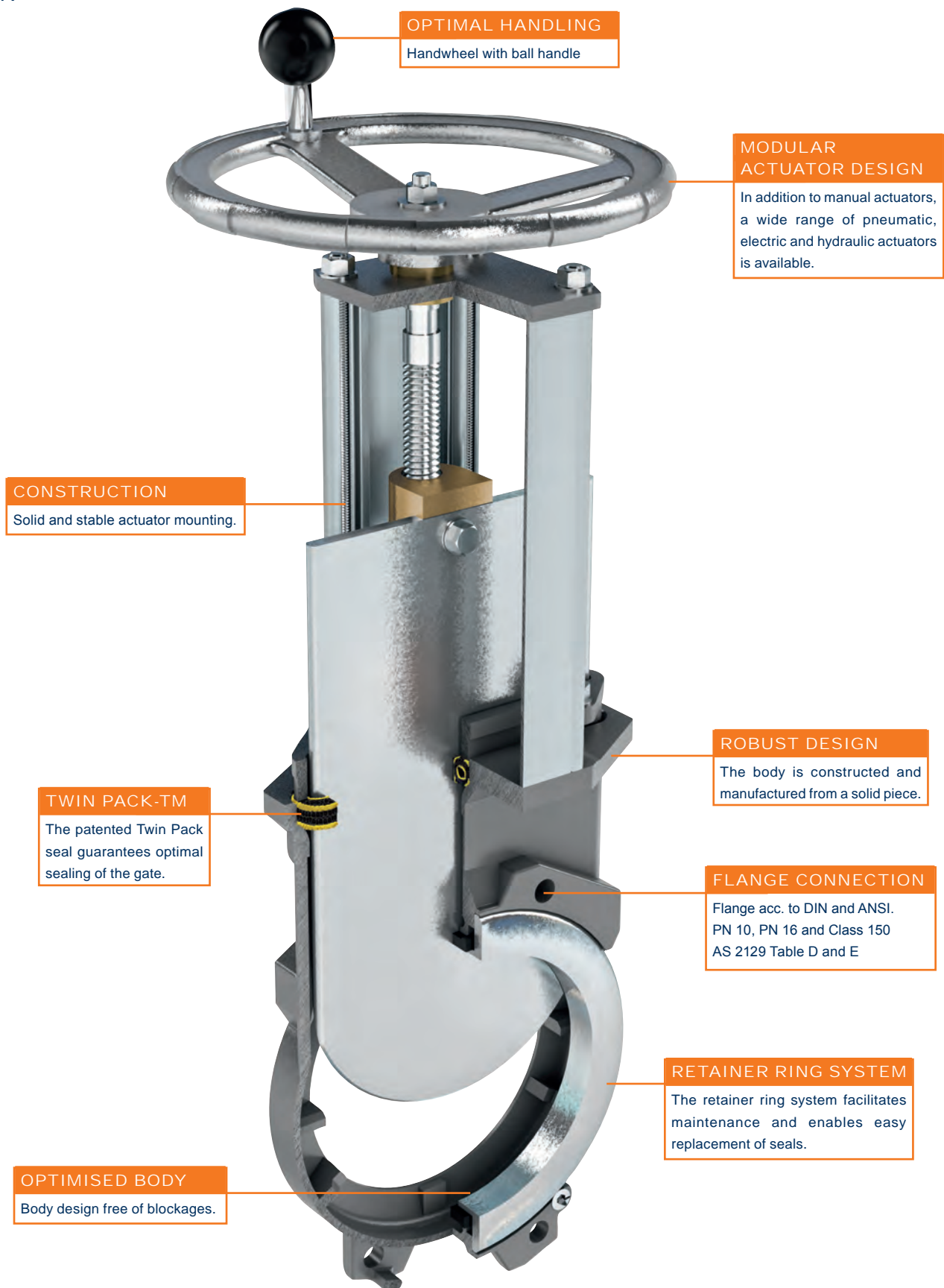

OPTIMAL HANDLING

Handwheel with ball handle

MODULAR ACTUATOR DESIGN

In addition to manual actuators, a wide range of pneumatic, electric and hydraulic actuators is available.

CONSTRUCTION

Solid and stable actuator mounting.

TWIN PACK-TM

The patented Twin Pack seal guarantees optimal sealing of the gate.

ROBUST DESIGN

The body is constructed and manufactured from a solid piece.

FLANGE CONNECTION

Flange acc. to DIN and ANSI.
PN 10, PN 16 and Class 150
AS 2129 Table D and E

RETAINER RING SYSTEM

The retainer ring system facilitates maintenance and enables easy replacement of seals.

OPTIMISED BODY

Body design free of blockages.

STAFSJÖ KNIFE GATE VALVES

Technical data

Nominal diameters:

DN 50 – DN 1200

Flange accommodation:

EN 1092 10/16

ASME Class 150

AS 2129 Table D and E

Form of counter flange sealing surfaces:

EN 1092 Form A/B

ASME RF, FF

Top flange:

EN ISO 5211

Marking:

EN 19

Tightness check:

EN 12266 (Leakage rate A)

Standard of fitness for use:

EN 593

Temperature range:

-20 °C to +160 °C

Operating pressure:

max. 16 bar



WB 11: DN 50 - DN 300

Easy installation in pipes thanks to integrated flange seals and bi-directional design. Minimal clearance volumes and a smooth body base promote optimal flow. Available with square flange connection (agricultural engineering).

WB 12



WB 12: DN 150 – DN 200

This bi-directional double flanged knife gate valve is specially designed for use in agricultural engineering. Thanks to its four-hole flange, it is often used in biogas plants as well as in agricultural vehicle and container construction.

WB 14



WB 14: DN 50 – DN 600

Robust construction from one piece. Full passage and bi-directional. Available in full lug-type version up to DN 600. Epoxy-coated inside and out.

XV



XV: DN 80 – DN 800

This compact knife gate valve is bi-directional and is designed for high differential pressures. Full passage and minimised clearance volumes result in a good flow characteristic. The flange ring system simplifies maintenance.

HG



HG: DN 80 – DN 800

This knife gate valve is especially suitable for statically charged and highly corrosive media. Thanks to the through-hole in the gate, it has excellent flow characteristics and no media can accumulate in the passage.

SLV



SLV: DN 50 – DN 800

Bi-directional knife gate valve with full, smooth passage for maximum flow rate. Suitable for sludges, slurries and abrasive media. Epoxy-coated inside and out.

MV



MV: DN 50 – DN 1200

Suitable for a wide range of applications. The modular design simplifies individual adaptation of the knife gate valve. The flange ring system simplifies maintenance and offers a large selection of sealing rings.



SPECIAL APPLICATIONS

Series production is our business – the development of customised solutions for special applications is our passion.

For more than 40 years we have been developing tailor-made solutions in close collaboration with our customers, for challenging fields of application that simply require more than a standardised valve product. This has resulted in countless variations.

Many of them have been developed to series production, others are manufactured in small batches for selected applications. We can only show you the tip of the iceberg here...

Challenge us!

Example fields of application

- FS-M: Mixers, silos, granulate, weighing containers
- Z 611-K: Food and beverage industry, foodstuffs
- CK: Food processing industry, bulk goods, grain, animal feed, waste air and dust separation
- BE 50 / 80 / 250 / 300: Container construction, silos, hazardous goods containers for varnishes, paints, solvents, resins
- TW 80 / 100 / 150 / 200: Container construction, silos
- Q 011: Ventilation systems, hospitals, nuclear power plants, research laboratories
- Cycle-lock: Dosing and discharging bulk goods, weighing technology, bagging plants
- K016: Swimming pool technology, PVC piping
- ViDos: Dosing and discharging of solid materials, Pneumatic materials handling technology

Plastic valve K 016



K 016: DN 32 – DN 100

Butterfly valves with bended sockets to be installed in PVC-Pipe Systems. For maintenance services, the valve body can be disassembled.

Process valve



Z 611-K: DN 50 – DN 300

Wafer type butterfly valve with split stainless steel body for use in the food and beverage industry. Soft seated and PTFE lined versions are available.

Container valve



BE: DN 50 – DN 300

Shut-off valve for mounting to the outlet of silos and containers.

Valves for tank trucks



TW: DN 80 – DN 200

A valve series designed for flanges to Tank Truck standard.

Available in two versions:

- Metal seated (TW-M)
- Soft seated (max. pressure: 6 bar)

Pipe system valve



CK: DN 80 – DN 250

CK pipe system valve in two versions with keyways for mounting locking rings:

- metallicly seated
- with rubberised butterfly disc (tight to 2 bar)

Safety valve



Q 011: DN 80 – DN 400

Butterfly valve with eccentrically mounted butterfly disc and safety seal with test connection for gas-tight shut-off of plant areas.

SYSTEM SOLUTION CYCLE LOCK

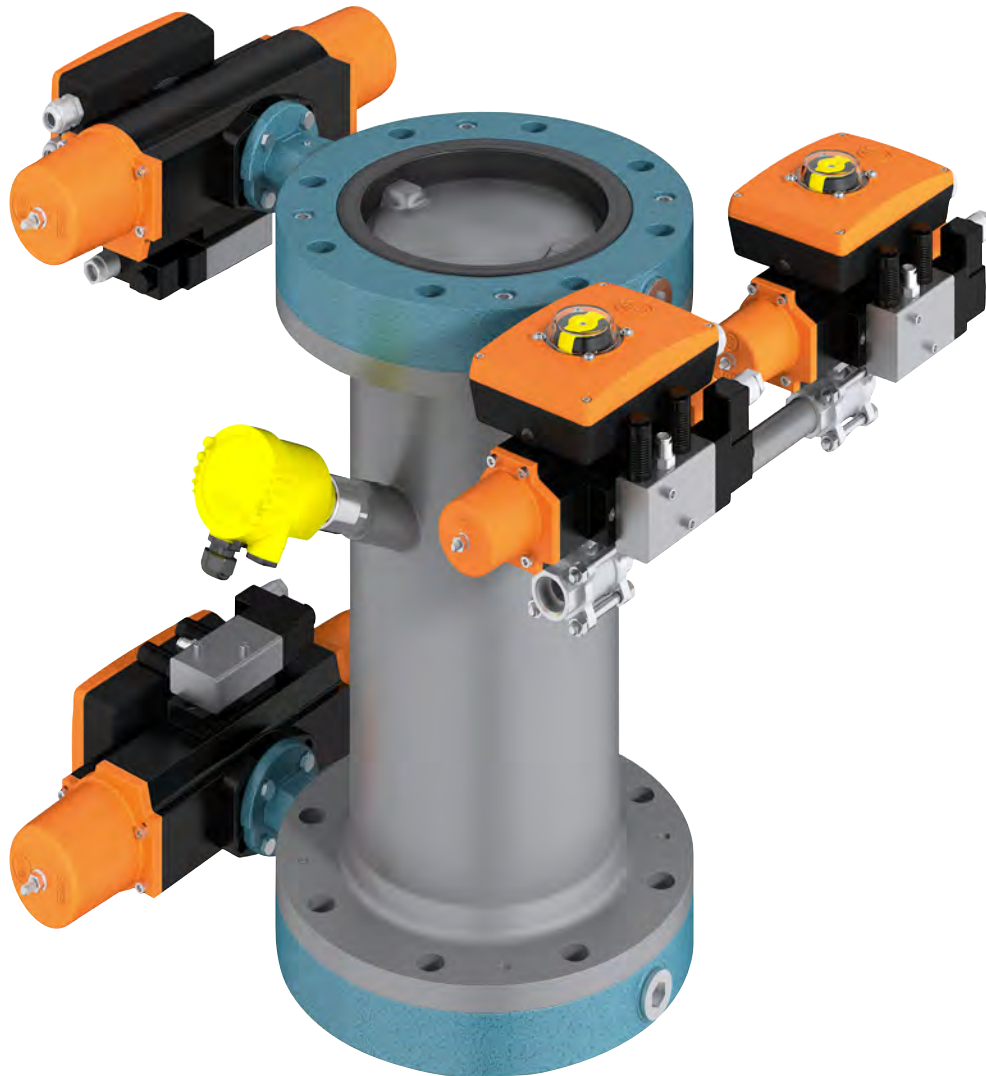

SYSTEM SOLUTION CYCLE LOCK: DN 50 – DN 600

EBRO cycle-locks are installed where powdered media is discharged from silos, receiver tanks and bigbags and dosed in many cases. They are also used for feeding into downstream production processes, as well as for inertisation of products during transfer operations.

The cycle-lock TS is available in nominal diameter DN 50 - DN 600. The geometry of the filling pipe depends on the specific properties of the products to be passed through the valve. The chamber volume can be adapted individually. The communication is based on conventional signaling equipment and can be integrated to existing control systems without any problems.

Impeller valve



FS-M: DN 150 – DN 400

Impeller valve for shut-off or control of bulk material flows with control for metered filling.

Vibrating disc



ViDos: DN 150 – DN 400

A wafer type process valve with a vibrator mounted on the lower shaft. The disc is set into linear vibrations before opening to keep the product in motion thus reducing compression. The frequency is controlled via air pressure.

Inflatable liner



INFLAS: DN 80 – DN 400

The sealing system was developed for use with highly abrasive or very sensitive media. Available for all resilient seated butterfly valves with replaceable liner.

CHECK VALVES

Pinch valve



QV: DN 40 – DN 200

A pinch valve with fill passage for media like solid mattered waste water, mud and others. Combined with a solenoid valve, pneumatic operation is possible for different kind of media.

RSK



RSK: DN 32 – DN 400

These check valves are designed to prevent return flow in piping systems. They stand for a simple and reliable constitution and short face-to-face dimension.

DC



DC: DN 50 – DN 600

These check valves can be operated with low opening pressure. When the output pressure exceeds the input pressure, the disc closes and prevents the return flow.

THE WORLD OF EBRO ARMATUREN

Our international network



EBRO ARMATUREN Gebr. Bröer GmbH

Karlstr. 8
D-58135 Hagen

Tel. +49 (0)2331 / 904 – 0
Fax +49 (0)2331 / 904 – 111

A company of the Bröer Group

Current addresses can be found at
www.ebro-armaturen.com

